

# **Dřevěné vchodové dveře (rámové)**

**-Klasik 1**

**-Klasik 2**

**-Klasik 3**

**-Klasik 4**

**-Klasik 5**

**-Rustikál – Falc**

**-Rustikál – Falc s obloukem**

**-Rustikál – oboustranný rámeček**

**-Rustikál – oboustranný rámeček s obloukem**

**-S okopem dovnitř otv. bez prahu**

**-S okopem dovnitř otv. a prahem 20mm/32mm**

**-S okopem ven otv. bez prahu**

**-S okopem ven otv. a prahem 20mm/32mm**

**-Bez okopu dovnitř otv. bez prahu**

**-Bez okopu dovnitř otv. s prahem 20mm/32mm**

**-Bez okopu ven otv. bez prahu**

**-Bez okopu ven otv. s prahem 20mm/32mm**

# Klasik 1

Typ 1

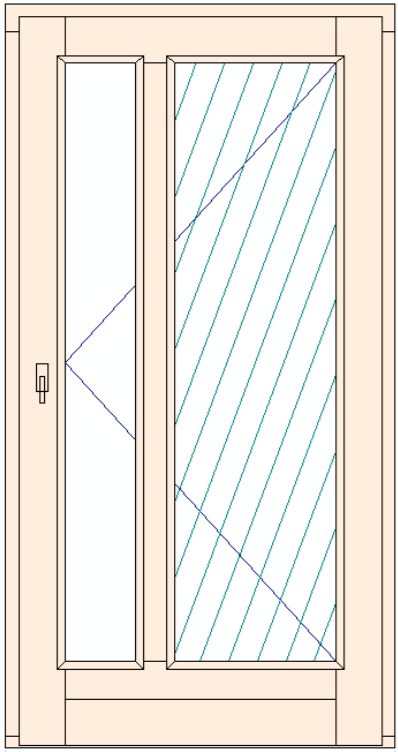

Typ 2

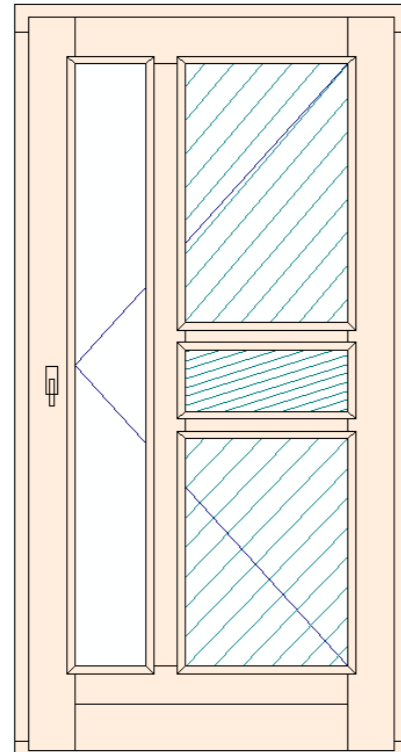

Typ 3

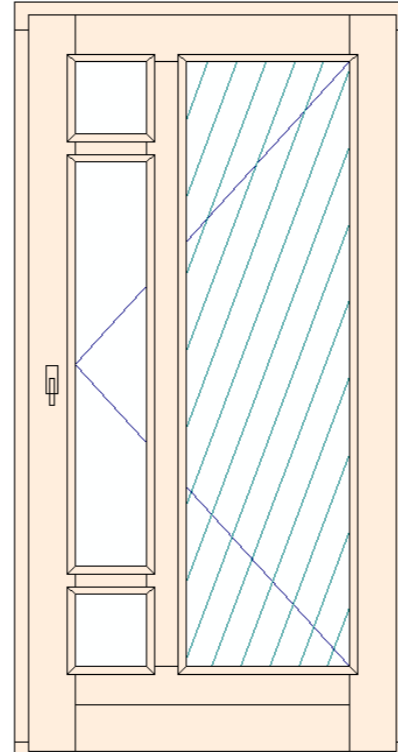

Typ 4

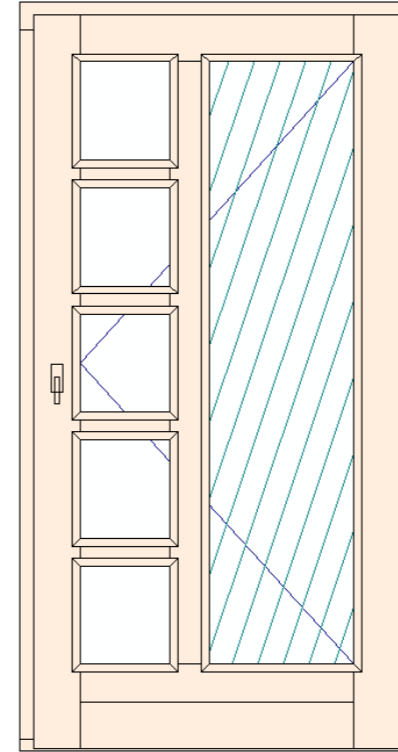

# Klasik 2

Typ 1

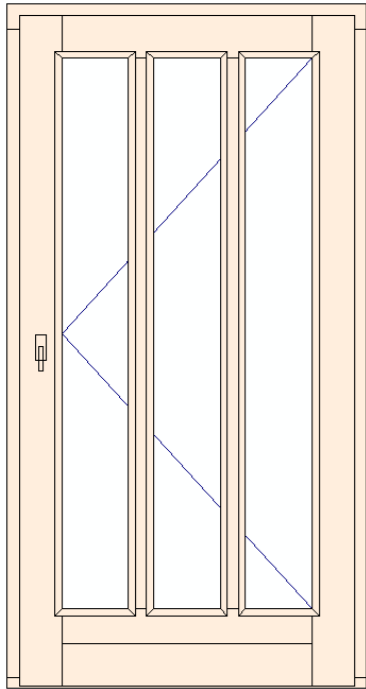

Typ2

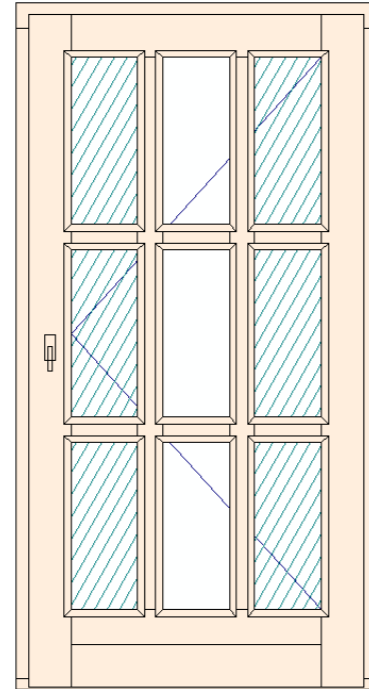

Typ 3

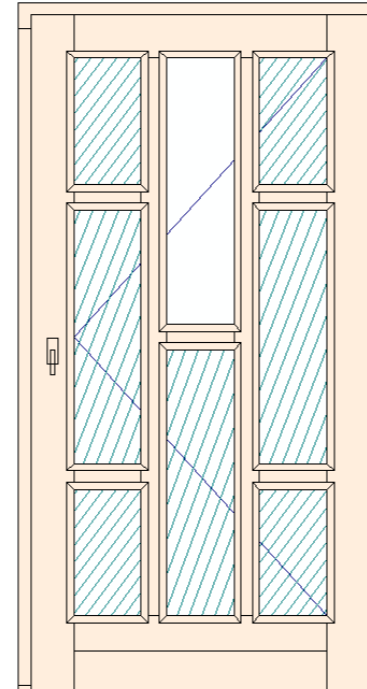

Typ 4

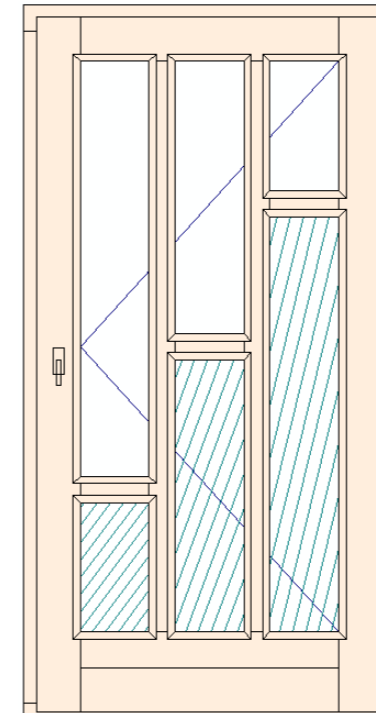

Typ 5

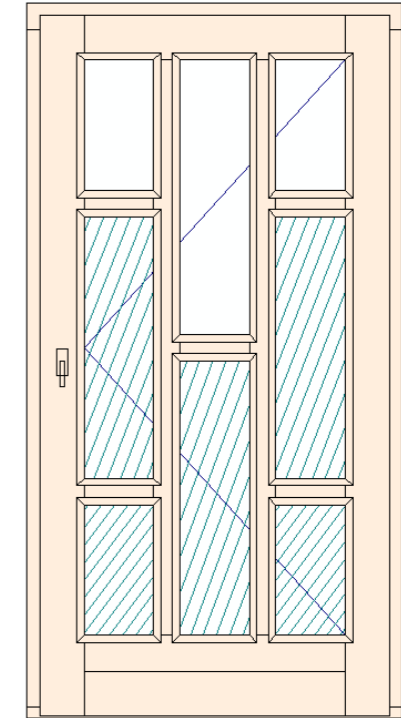

Typ 6

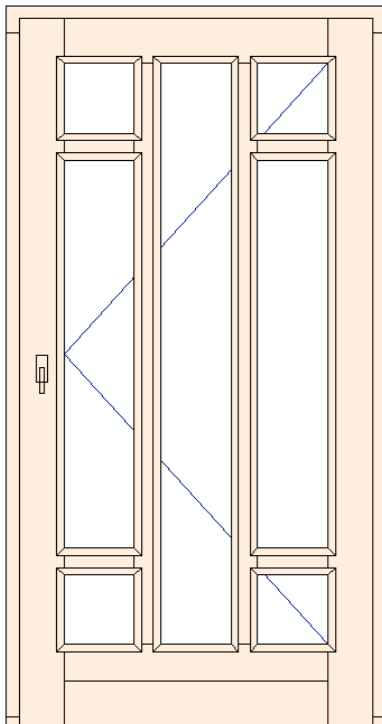

# Klasik 3

Typ 1

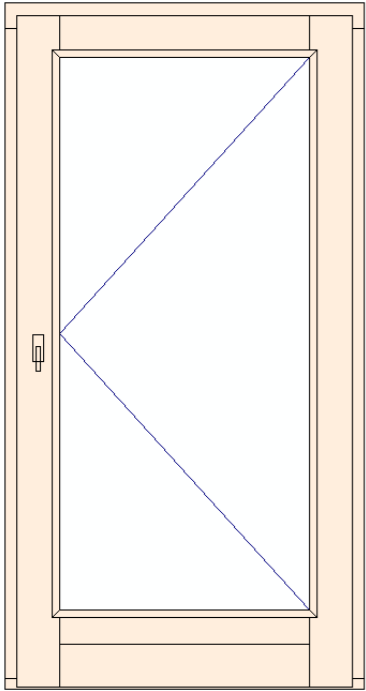

Typ 2

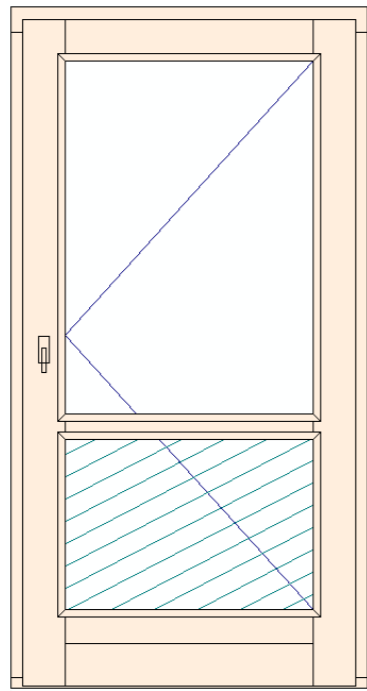

Typ 3

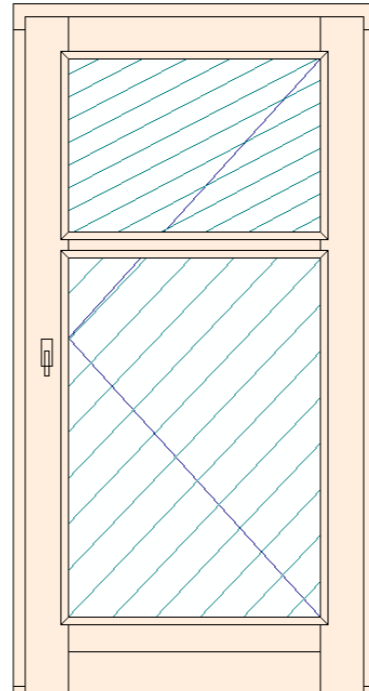

Typ 4

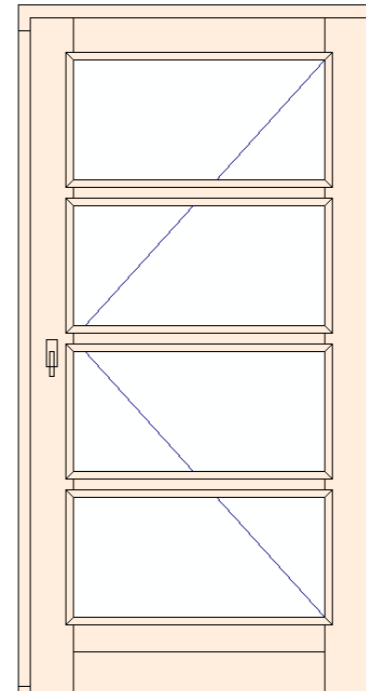

# Klasik 4

Typ 1

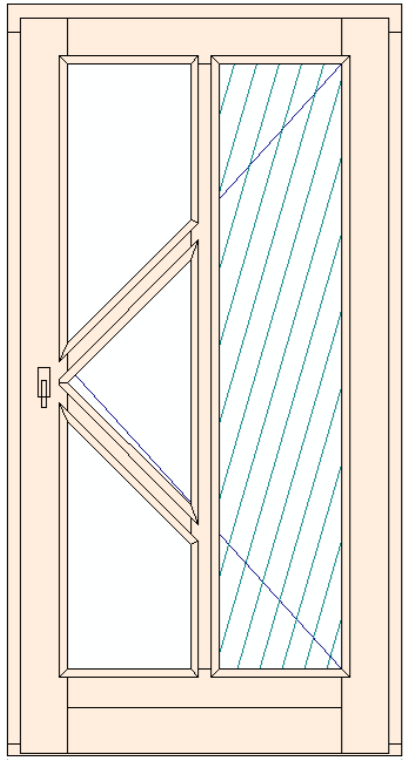

Typ 2

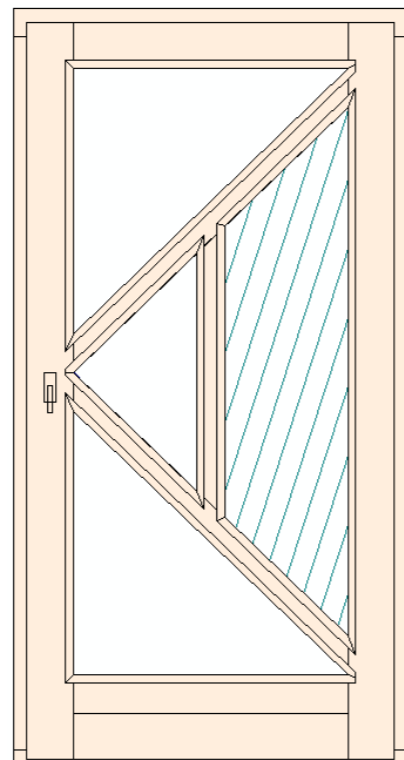

Typ 3

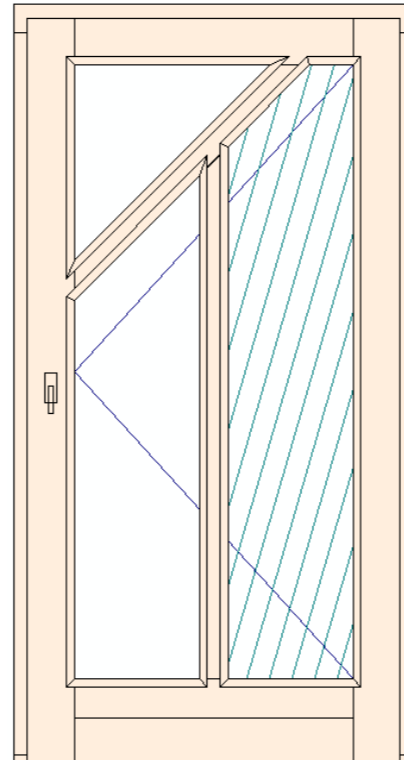

Typ 4

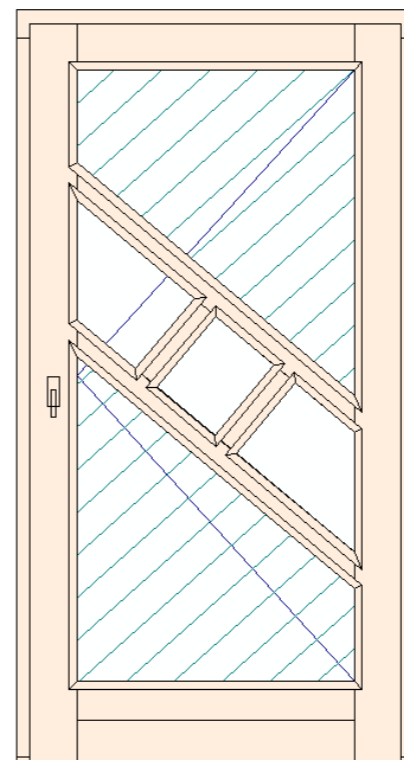

# Klasik 5

Typ 1

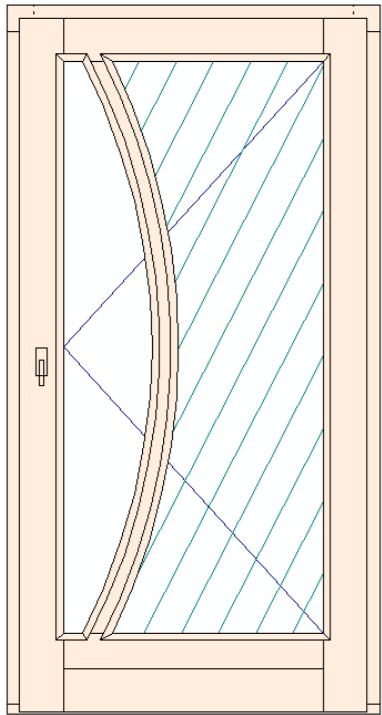

Typ 2

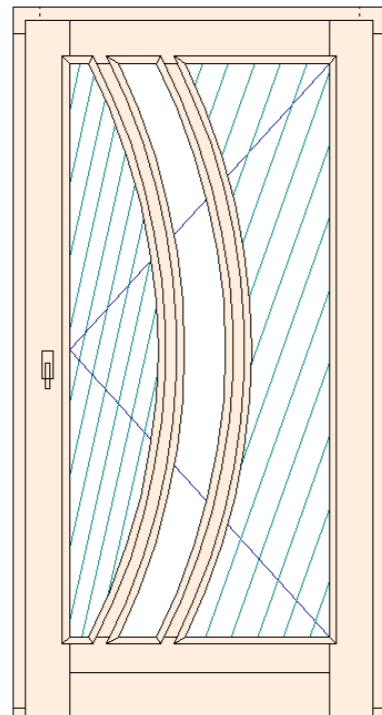

Typ 3

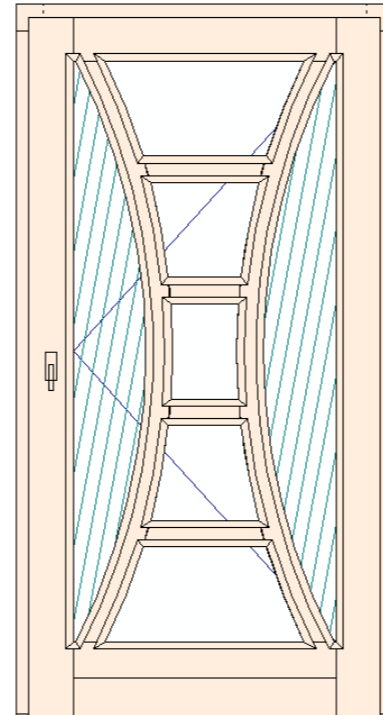

Typ 4

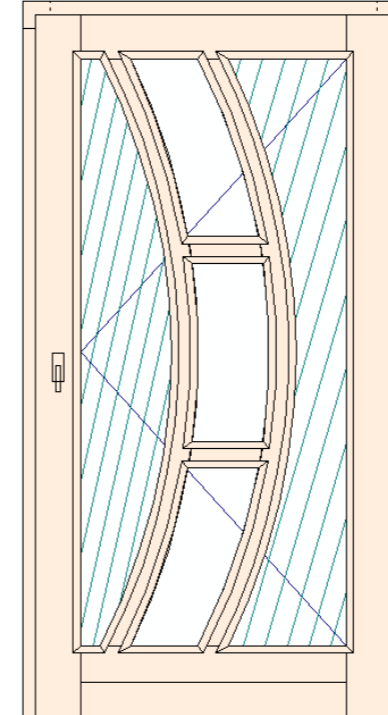

# Rustikál – Falc

Typ 1

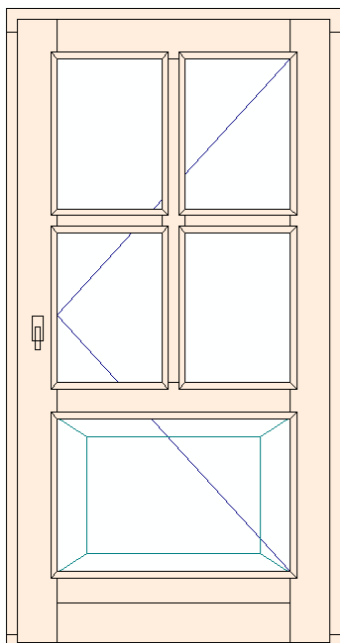

Typ 2

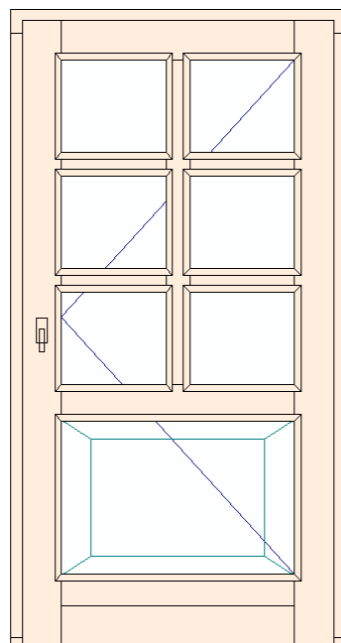

Typ 3

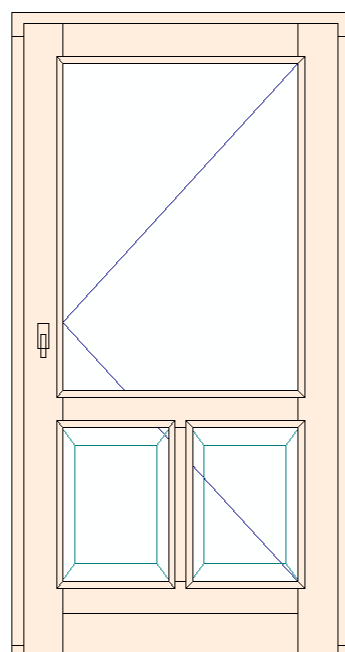

Typ 4

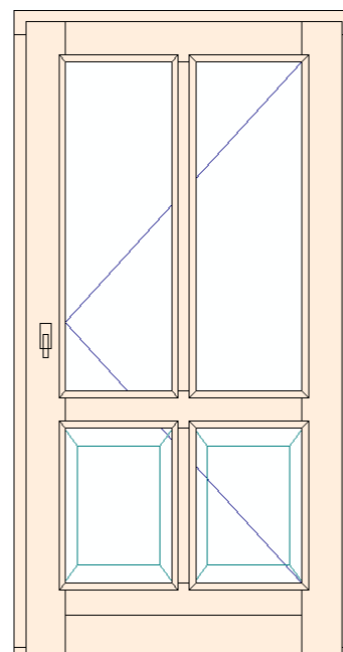

Typ 5

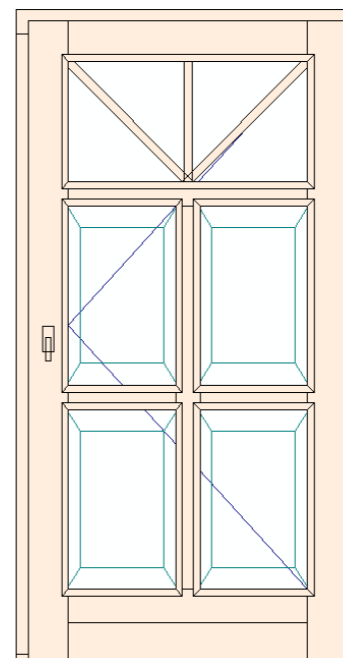

Typ 6

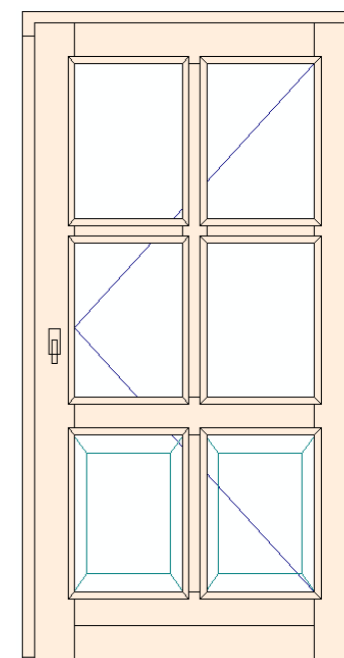

Typ 7

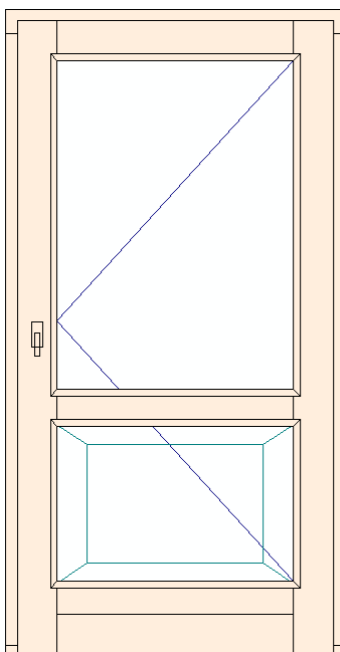

Typ 8

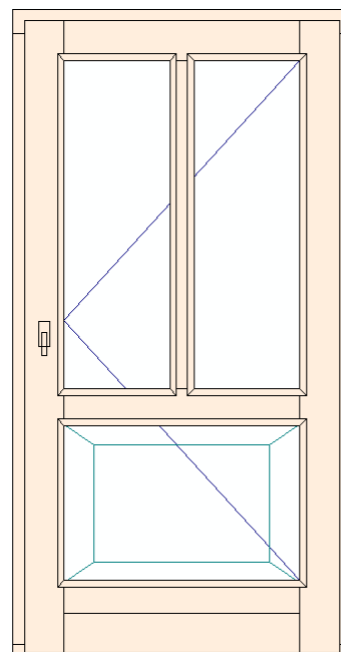

# Rustikál – Falc s obloukem

Typ 1

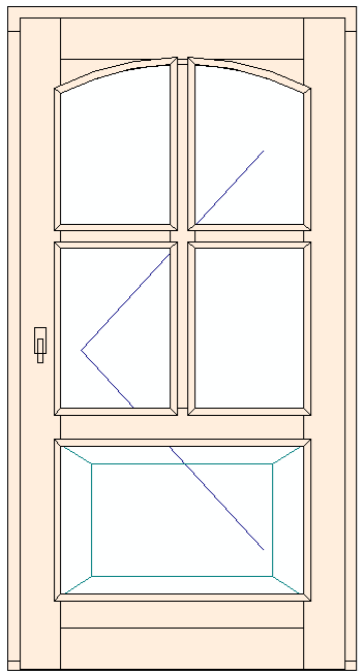

Typ 2

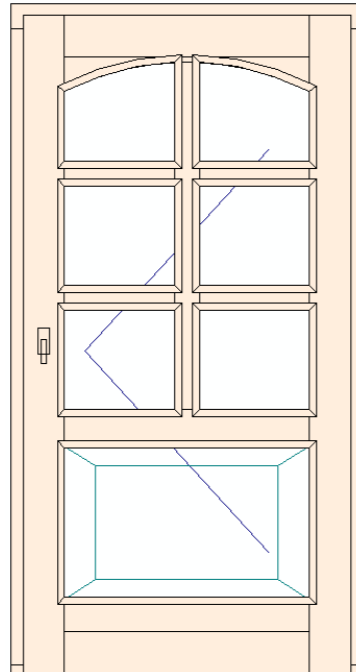

Typ 3

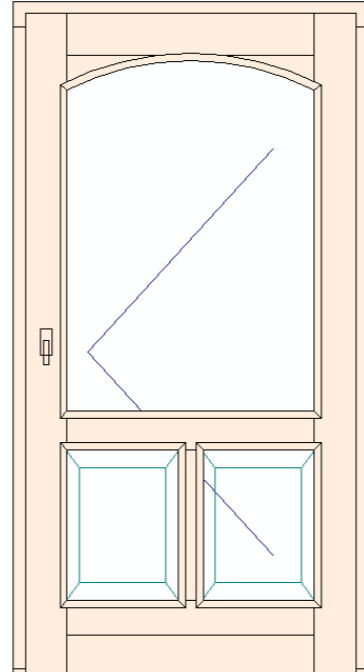

Typ 4

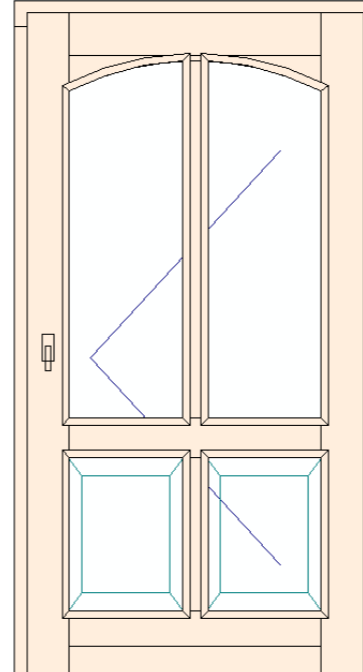

Typ 5

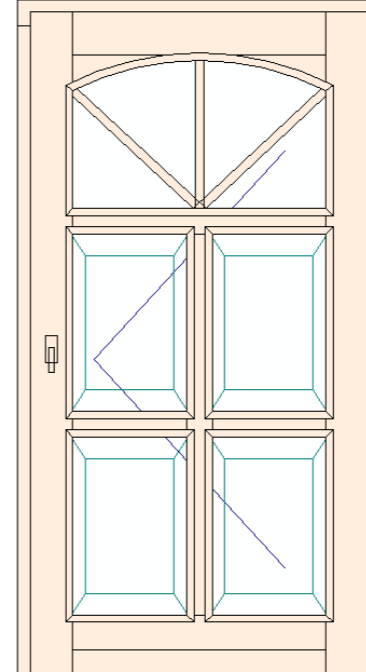

Typ 6

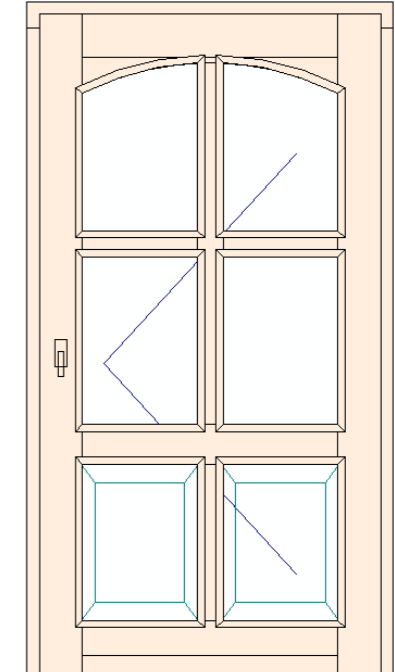

Typ 7

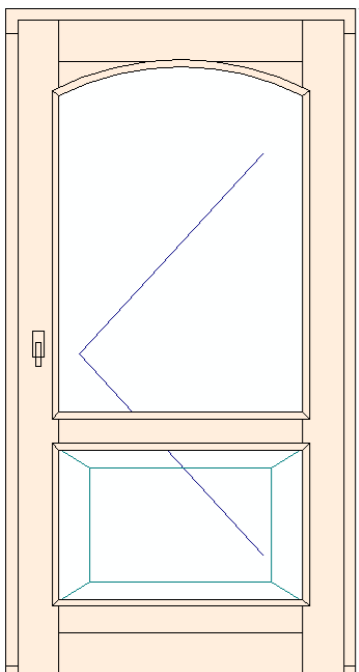

Typ 8

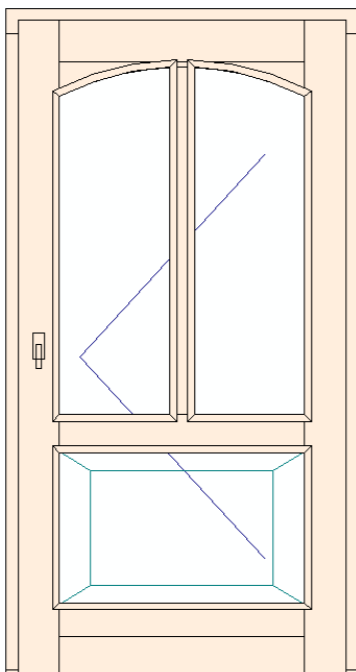



# Rustikál – oboustranný rámeček

Typ 1

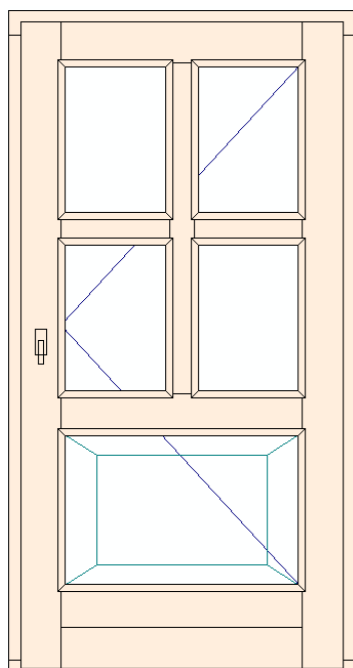

Typ 2

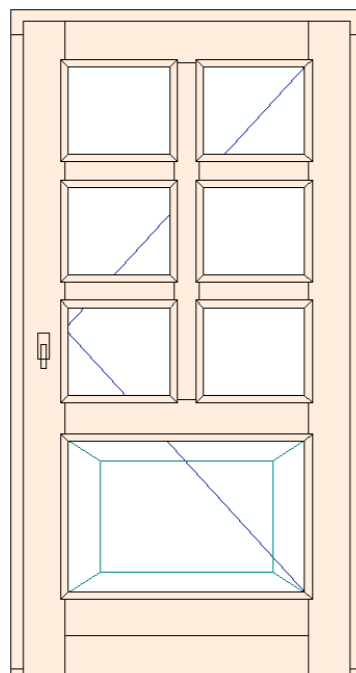

Typ 3

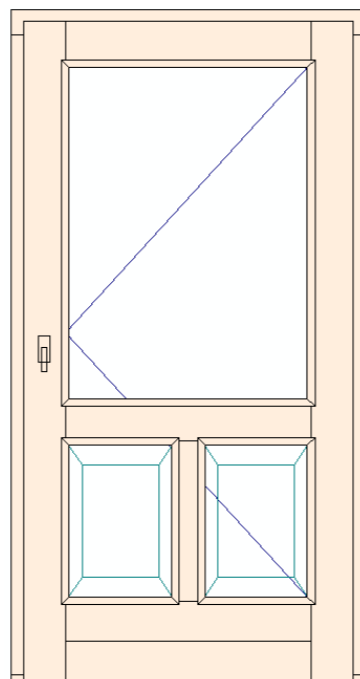

Typ 4

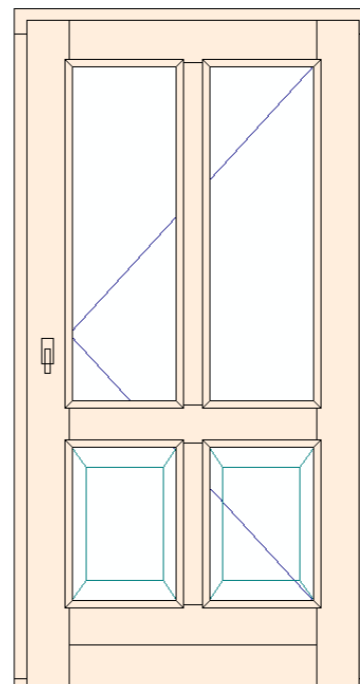

Typ 5

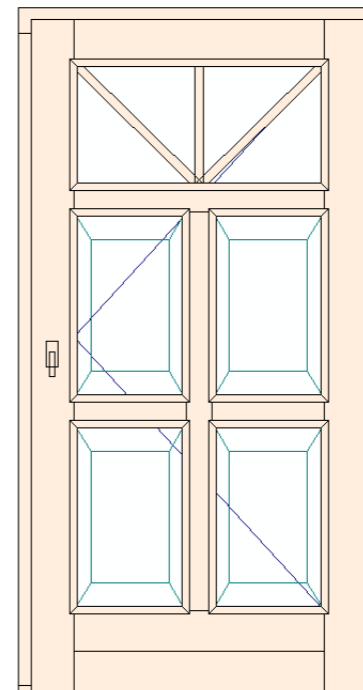

Typ 6

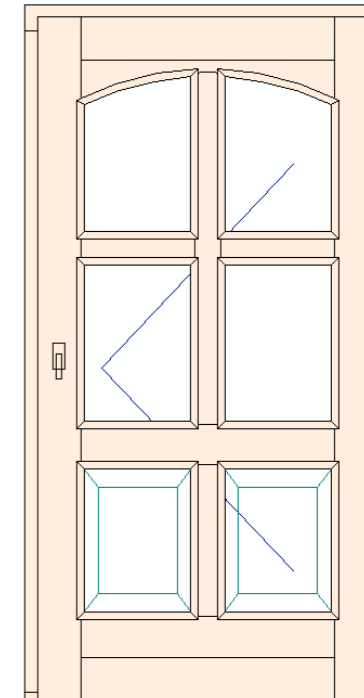

Typ 7

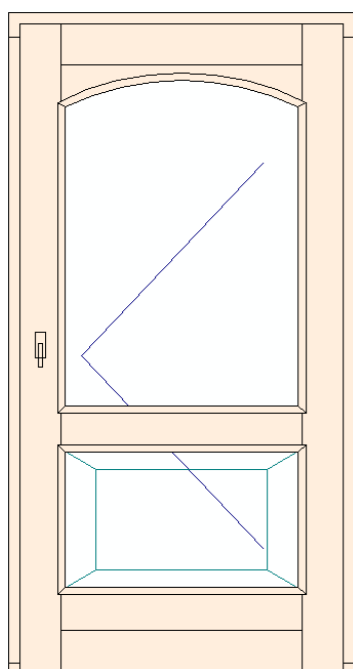

Typ 8

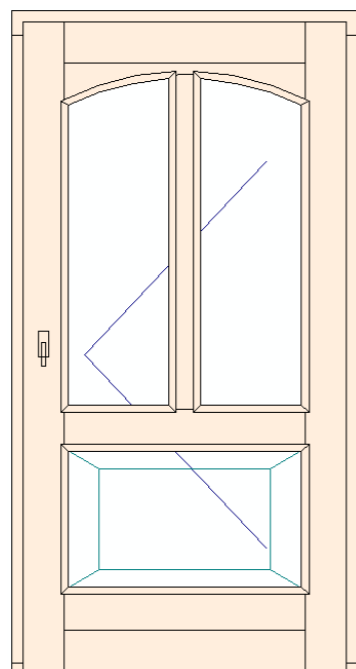

# Rustikál – oboustranný rámeček s obloukem

Typ 1

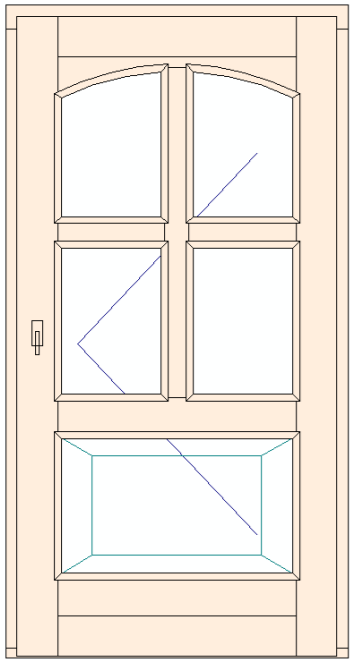

Typ 2

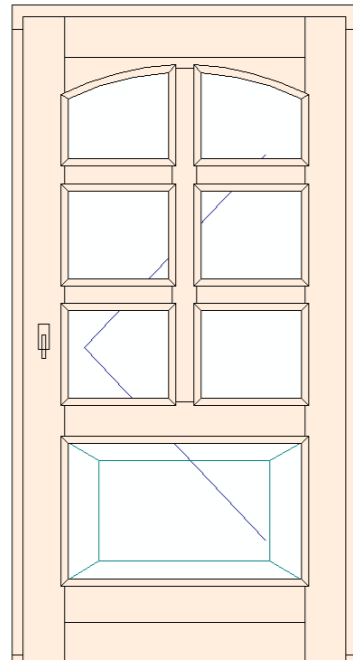

Typ 3

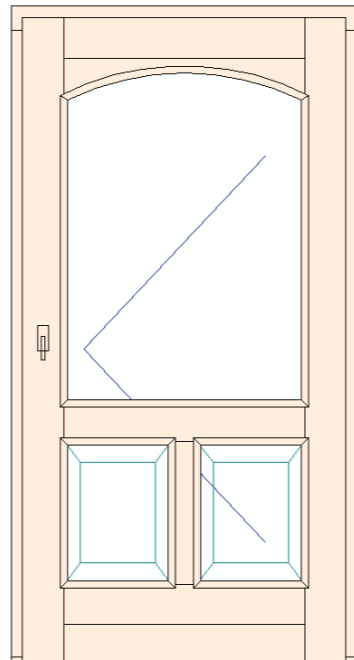

Typ 4

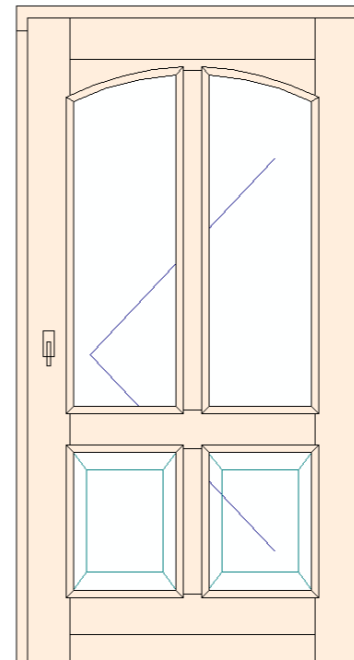

Typ 5

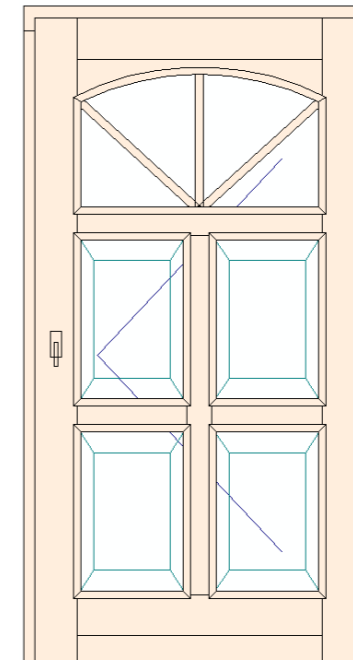

Typ 6

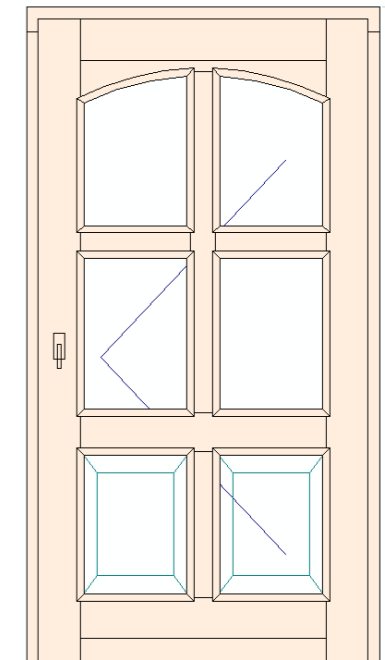

Typ 7

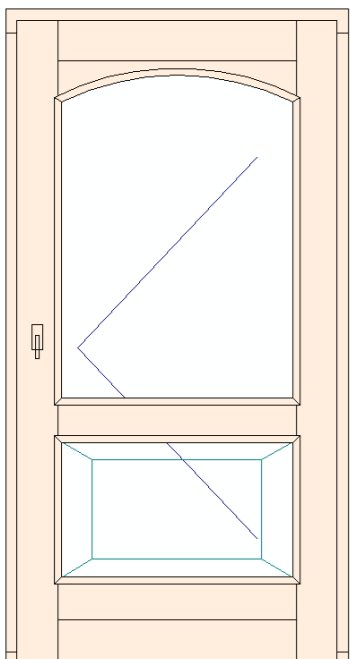

Typ 8

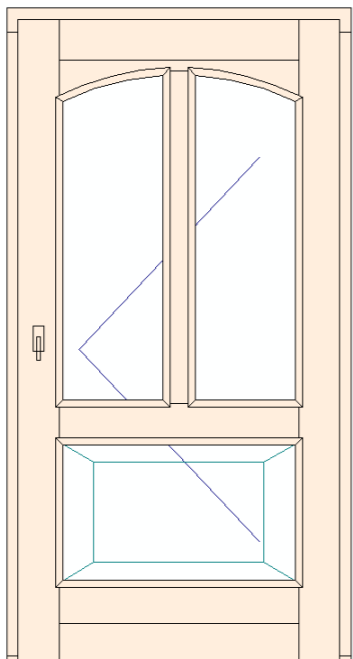

## S okopem dovnitř otvor. bez prahu

Jednokřídlé

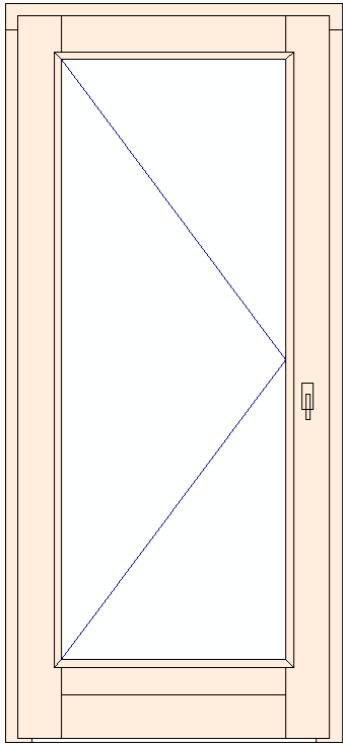

Dvoukřídlé

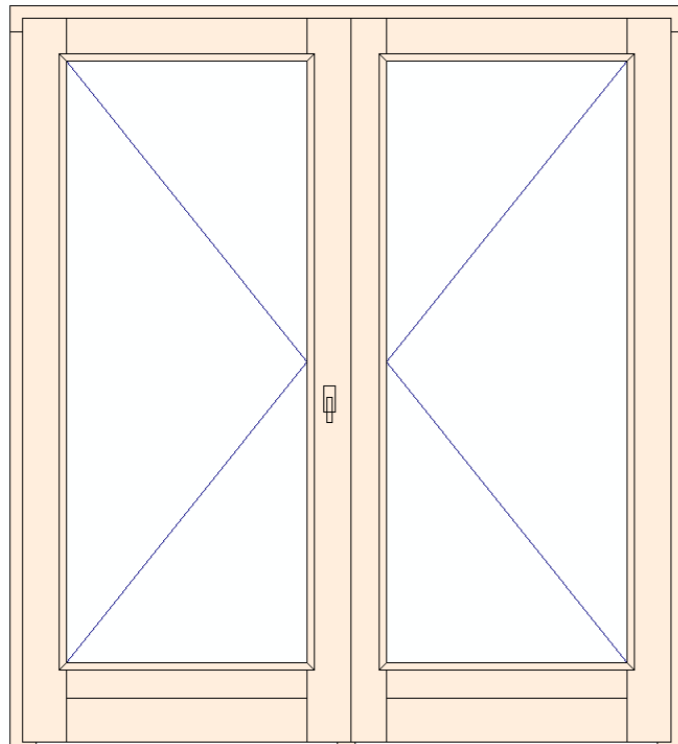

## S okopem dovnitř otv. a prahem 20mm/32mm

Jednokřídlé

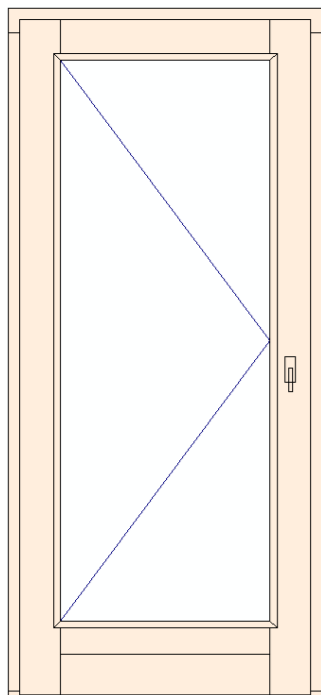

Dvoukřídlé

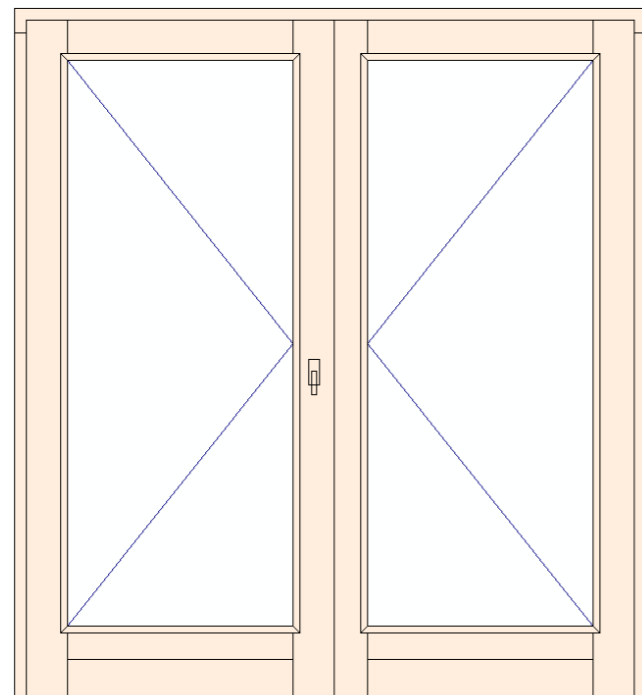

Jednokřídlé fix vpravo

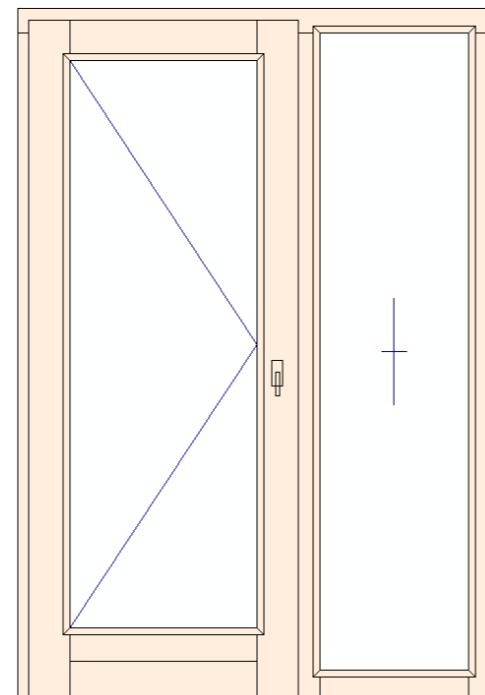

Jednokřídlé fix vlevo

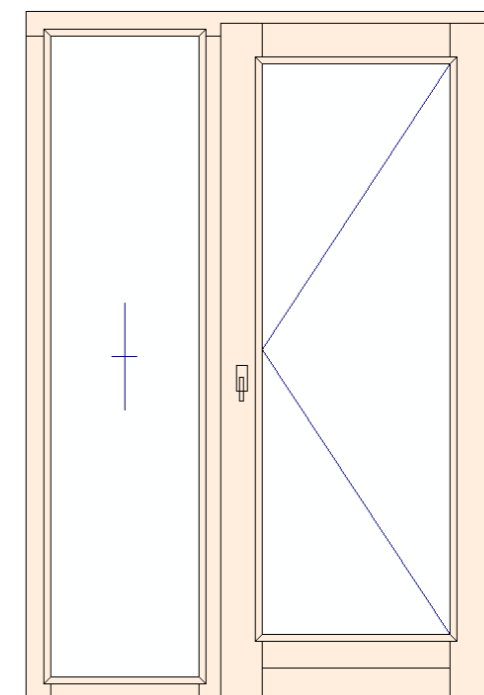

Jednokřídlé oboustranný fix

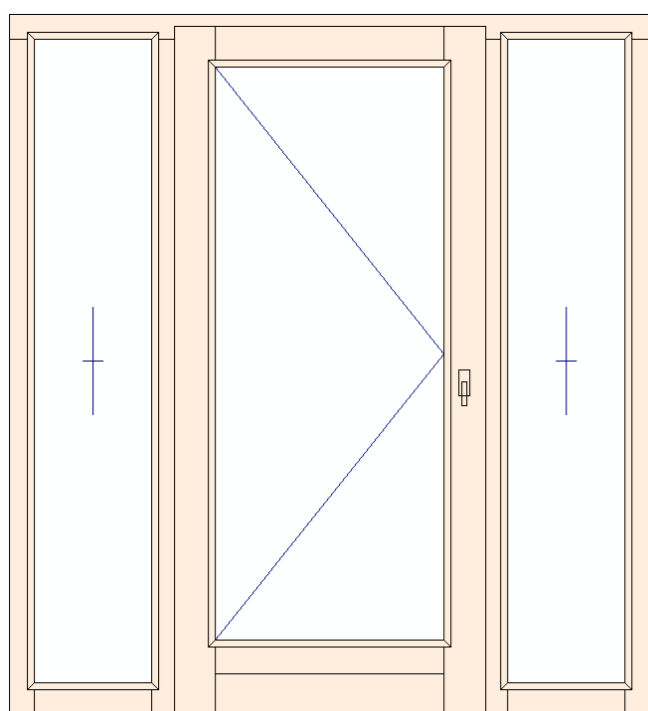

Jednokřídlé s nadsvětlíkem

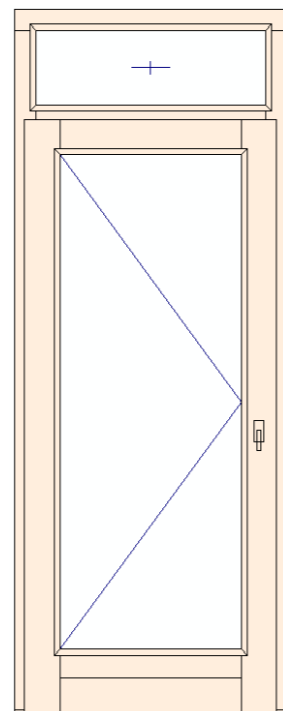

## S okopem ven otv. bez prahu

Jednokřídlé

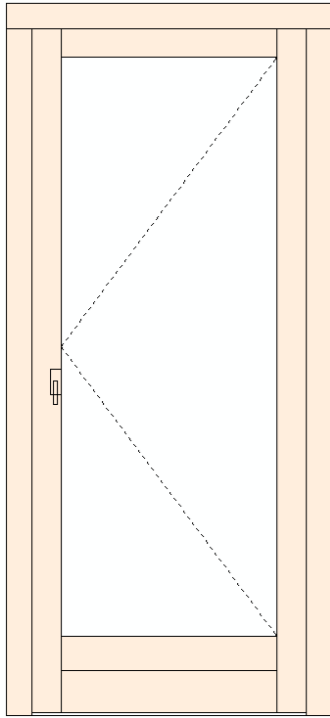

Dvoukřídlé

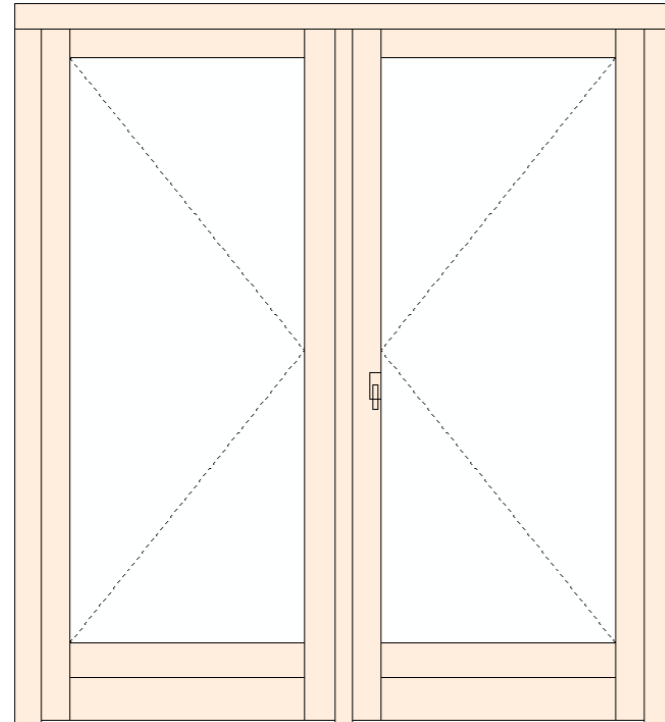

## S okopem ven otv. a prahem 20mm/32mm

Jednokřídlé

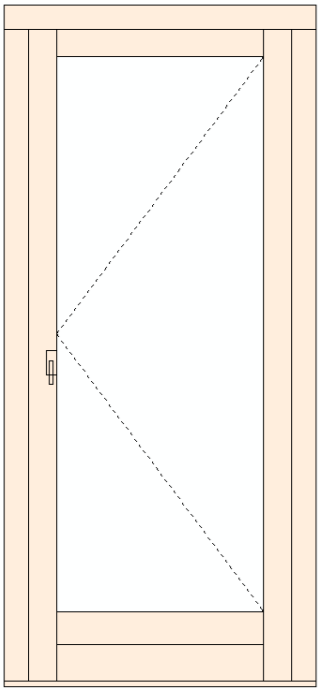

Dvoukřídlé

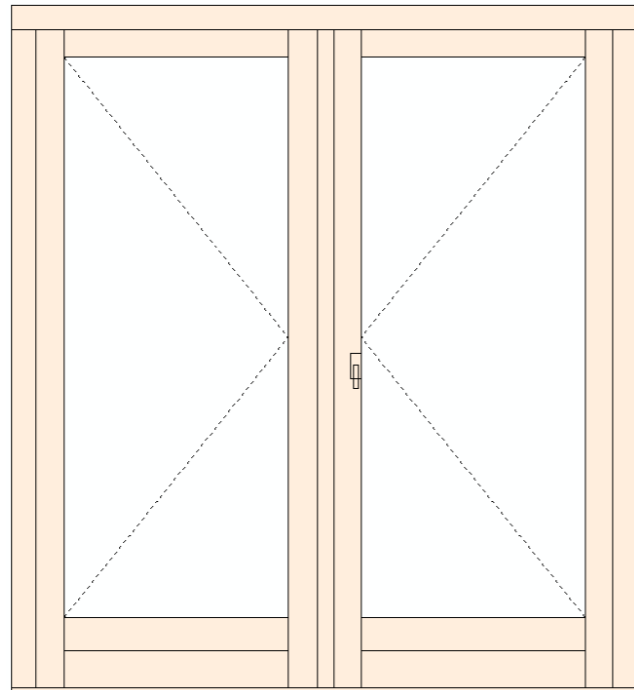

Jednokřídlé fix vlevo

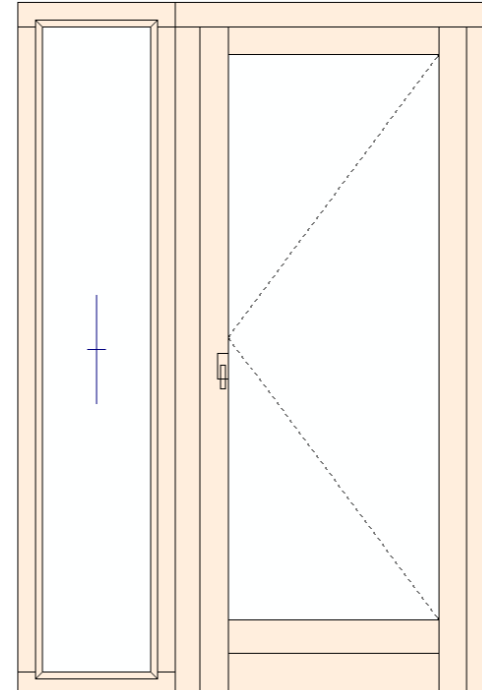

Jednokřídlé fix vpravo

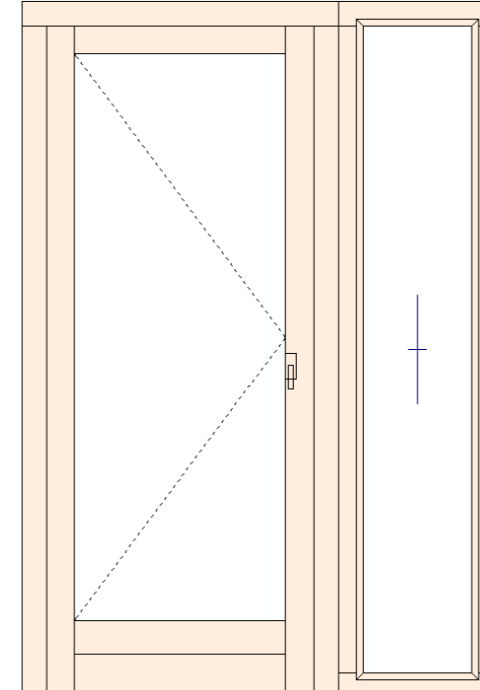

Jednokřídlé oboustranný fix

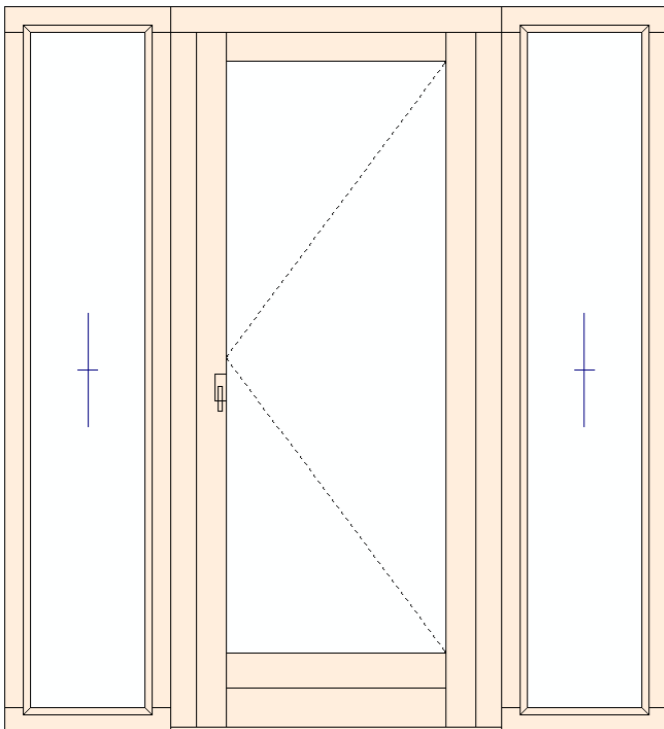

Jednokřídlé s nadsvětlíkem

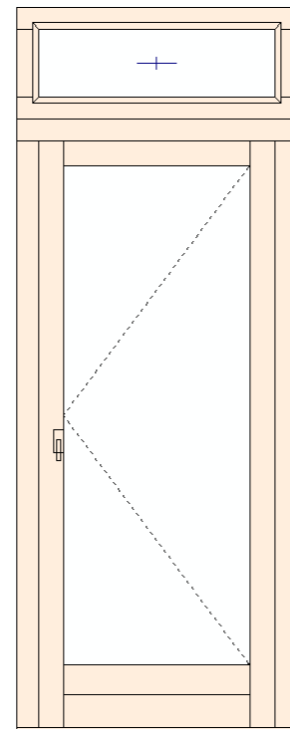

## Bez okopu dovnitř otvor. bez prahu

Jednokřídlé

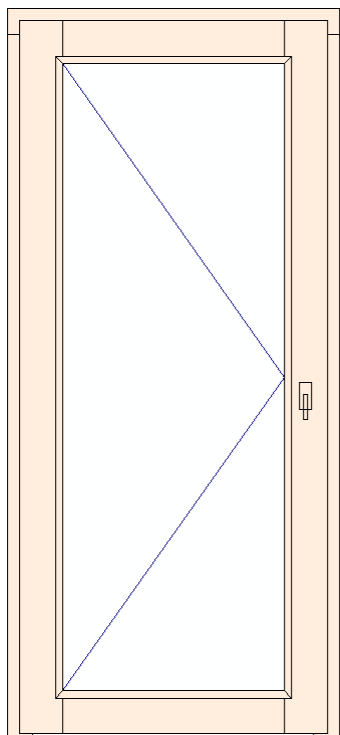

Dvoukřídlé

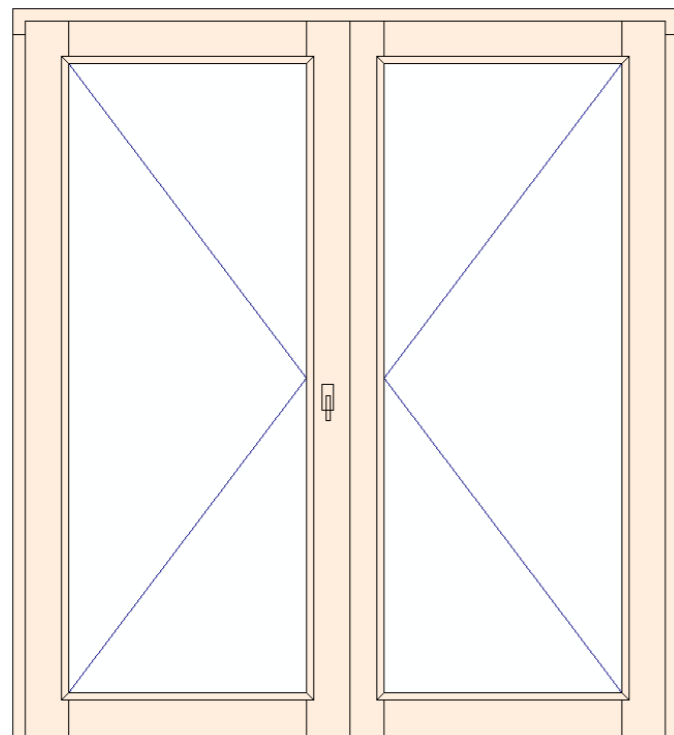

## Bez okopu dovnitř otv. s prahem 20mm/32mm

Jednokřídlé

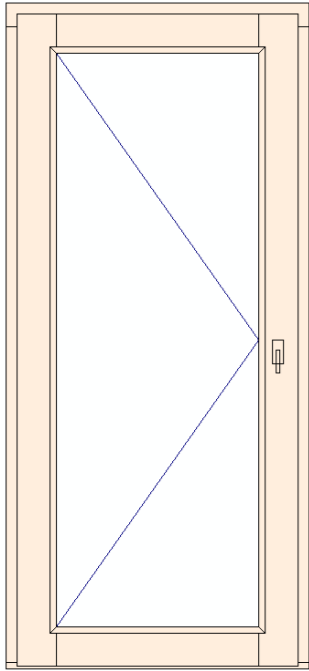

Dvoukřídlé

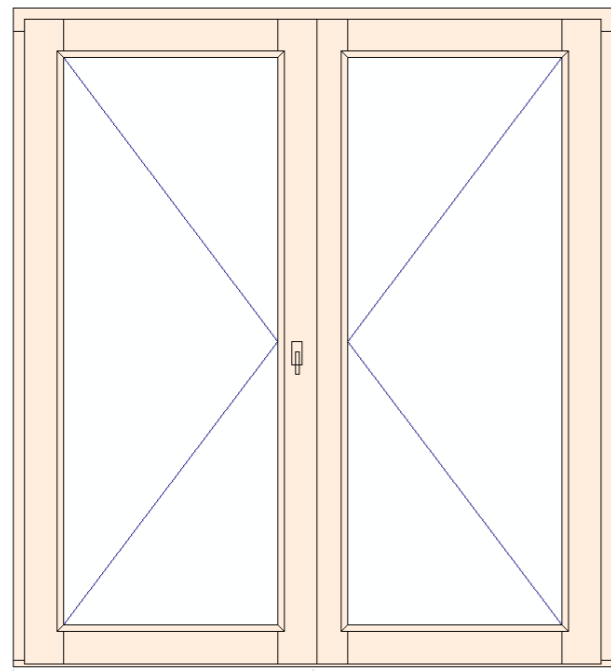

Jednokřídlé fix vpravo

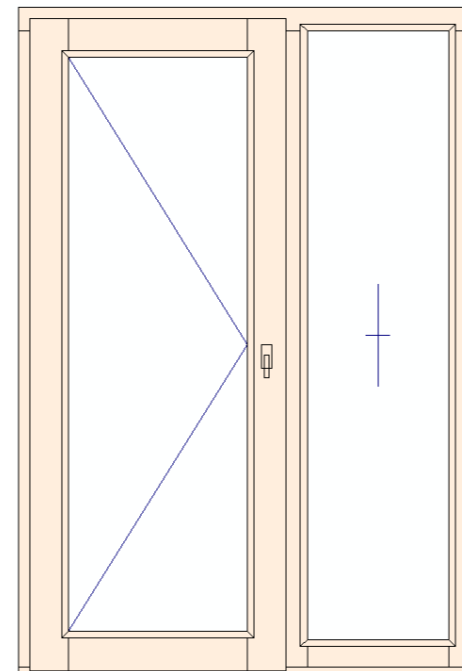

Jednokřídlé fix vlevo

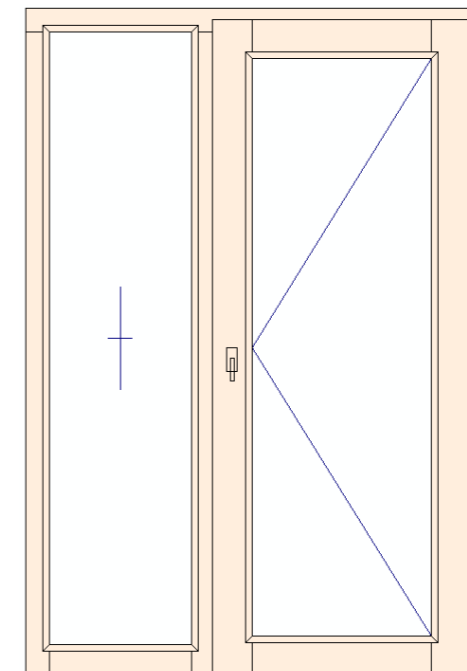

Jednokřídlé oboustranný fix

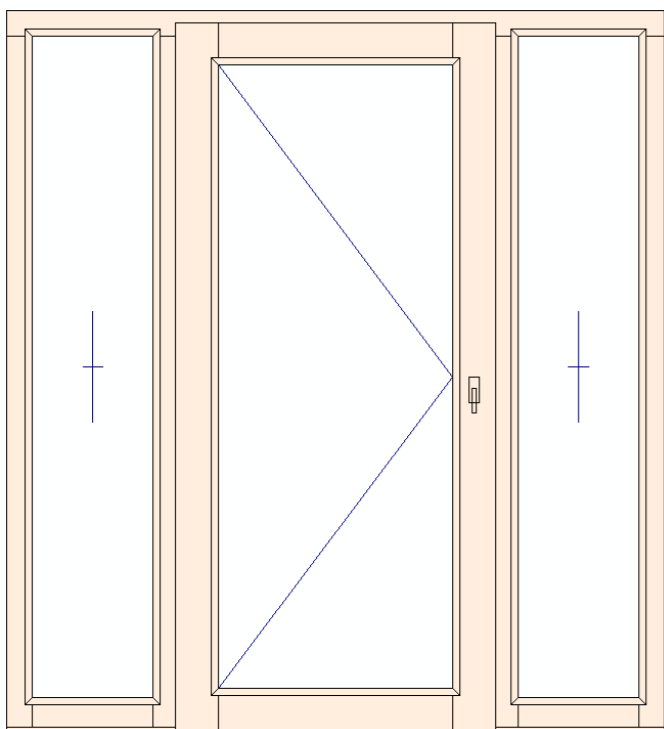

Jednokřídlé s nadsvětlíkem

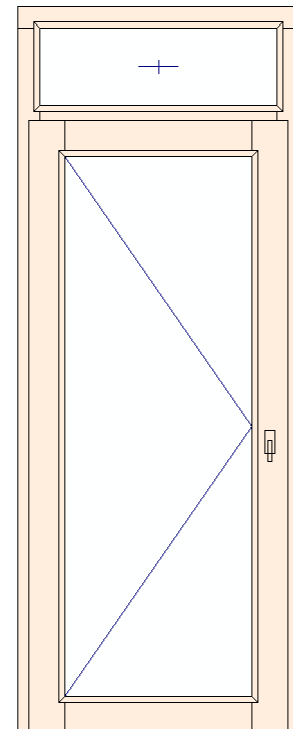



## Bez okopu ven otv. bez prahu

Jednokřídle

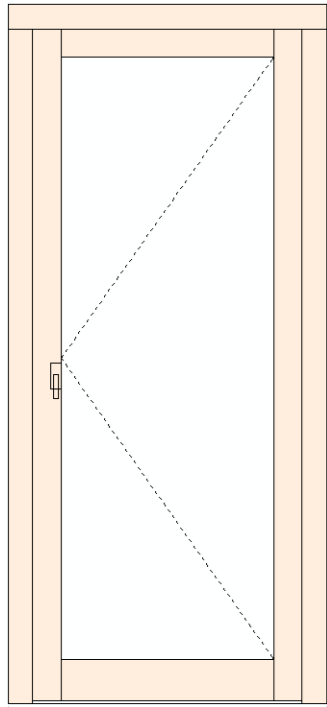

Dvoukřídle

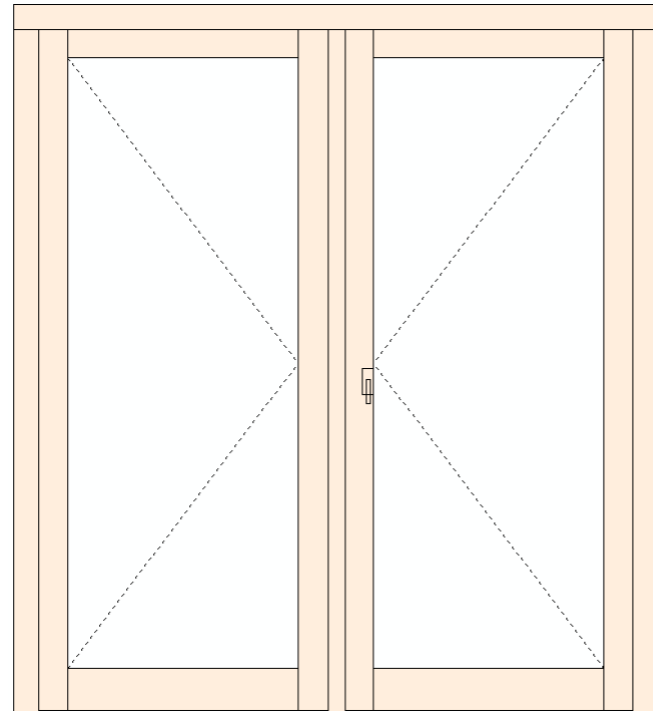

# Bez okopu ven otv. s prahem 20mm/32mm

Jednokřídlé

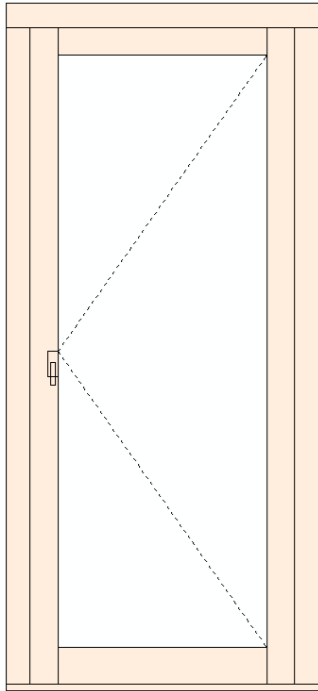

Dvoukřídlé

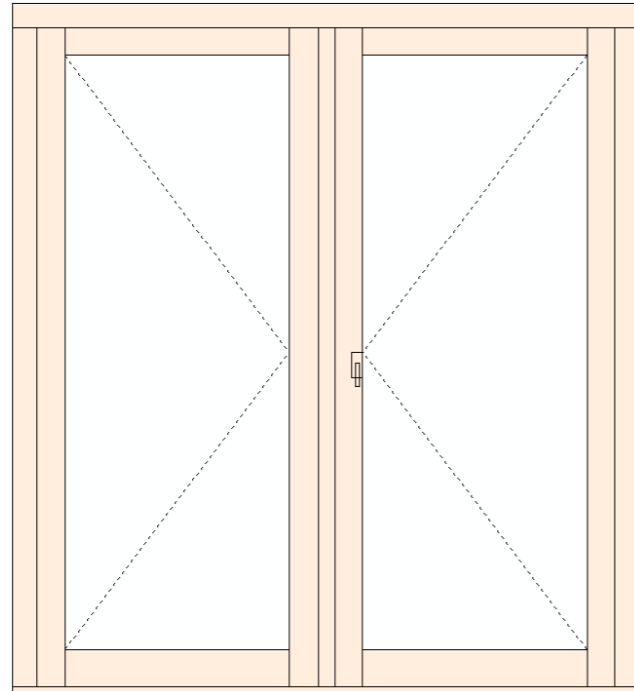

Jednokřídlé fix vlevo

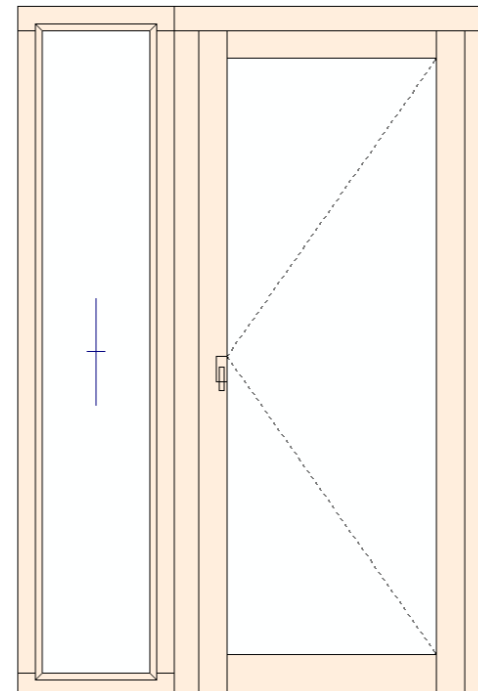

Jednokřídlé fix vpravo

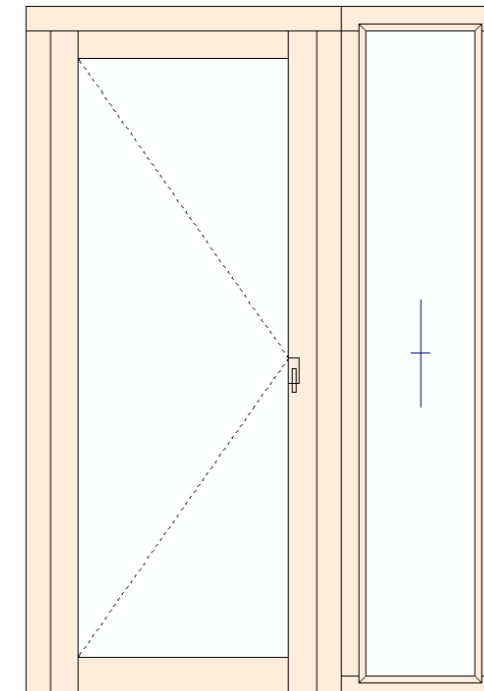

Jednokřídlé oboustranný fix

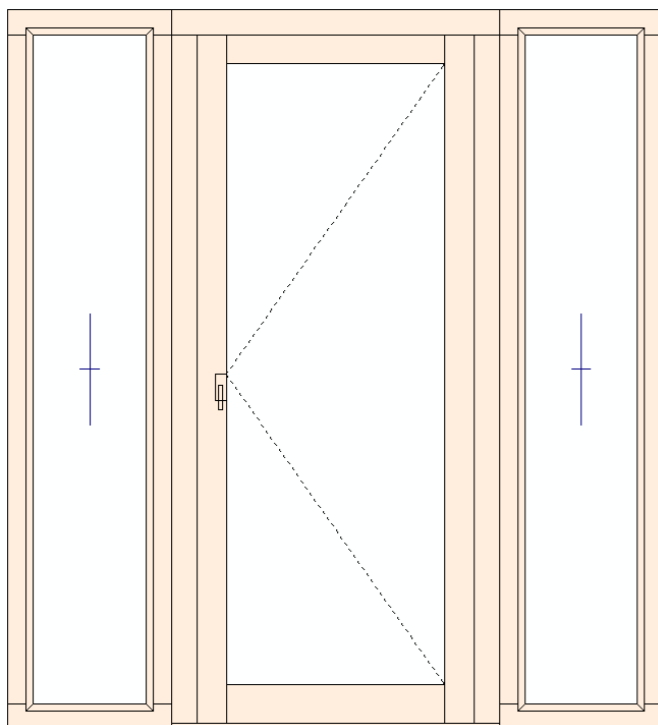

Jednokřídlé s nadsvětlíkem

